

Universität Potsdam
Institut für Informatik
Lehrstuhl Maschinelles Lernen



Maschinelles Lernen II

Niels Landwehr, Christoph Sawade, Uwe Dick, Tobias Scheffer

Organisation

- Vorlesung/Übung, praktische Informatik.
- 4 SWS.
- Ort: 03.04.1.02
- Termin:
 - ◆ Übung: Donnerstag, 10:00-11:30, (ab 28.04.2011).
 - ◆ Vorlesung: Donnerstag, 12:00-13:30

Organisation

- Webseite mit Folien und Übungsaufgaben
 - Am Tag nach der Vorlesung im Netz.
- Kalender.

Organisation

- Übungsaufgaben:
 - ◆ Am Tag nach der Vorlesung im Netz.
 - ◆ Werden in der darauffolgenden Übung besprochen.
 - ◆ Sie können für einzelne Aufgaben votieren.
 - ◆ Sie müssen für $2/3$ der Aufgaben des Semesters votieren, um die Prüfung abzulegen.
 - ◆ Sie rechnen votierte Aufgaben vor.
- Prüfung am Ende des Semesters.
 - ◆ 60 Minuten Vorbereitung, schriftliche Bearbeitung von drei Fragen
 - ◆ 15 Minuten Prüfungsgespräch

Überblick: Bayessche Netze

- Einleitung, exakte und approximative Inferenz.
- Lernen der Modellparameter.
- Niels Landwehr.

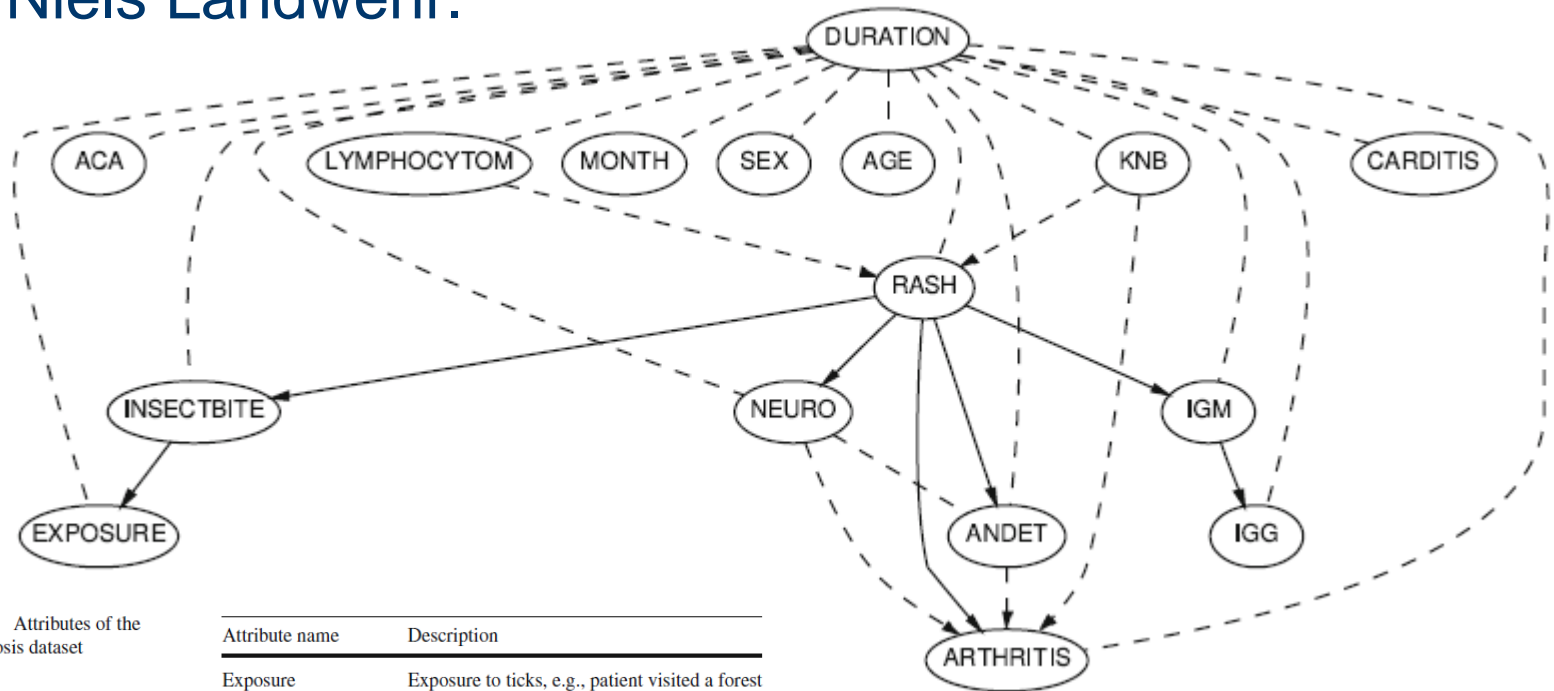
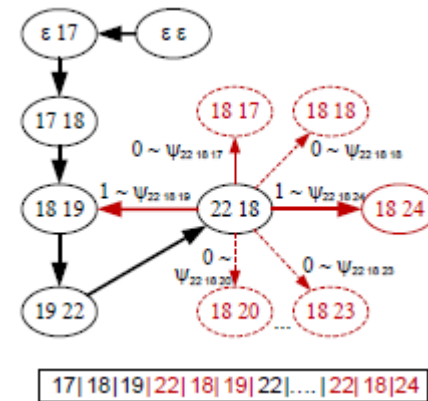
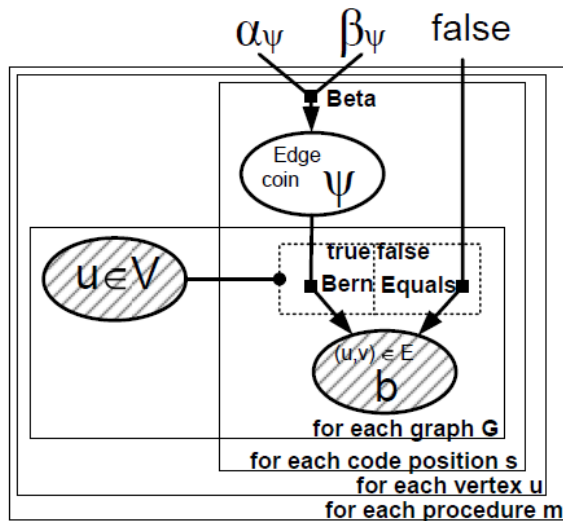

Table 4 Attributes of the Borreliosis dataset

Attribute name	Description
Exposure	Exposure to ticks, e.g., patient visited a forest
Duration	Duration of the disease
Month	Month the patient reported to a doctor
Rash	Whether the patient developed rash
IgM, IgG	Serological tests
Neuro	Neurological symptoms
ACA, KNB, Carditis, Lymphocytom, Andet	Various other symptoms

Überblick: Graphische Modelle

- Domänenspezifische, graphische Modelle.
- Plate-Diagramme, Inferenz.
- Niels Landwehr.



Überblick: HMMs, HM-SVMs, CRF

- Sequenzmodelle.
- Wahrscheinlichste Zustände für Beobachtung?
- Tobias Scheffer.

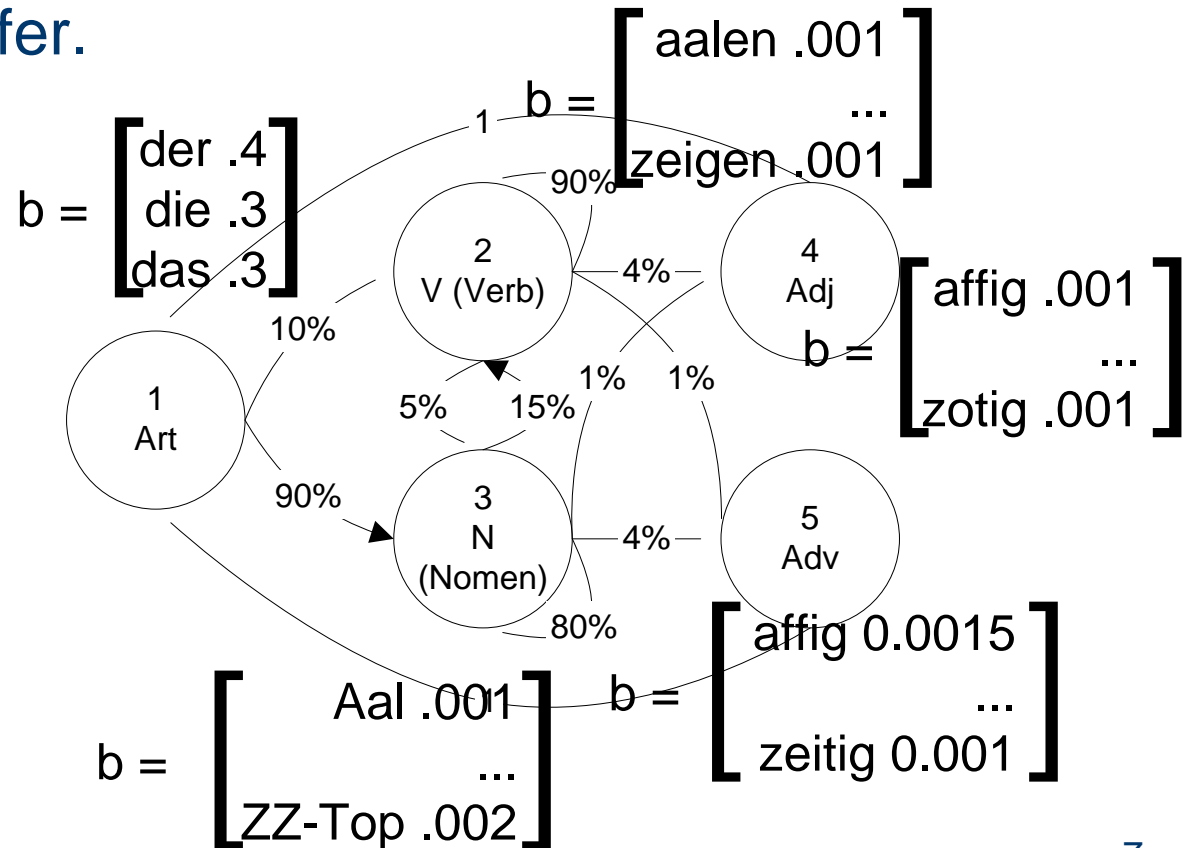

Überblick: Clustering.

- K-Means, Mischmodelle, EM.
- Niels Landwehr.

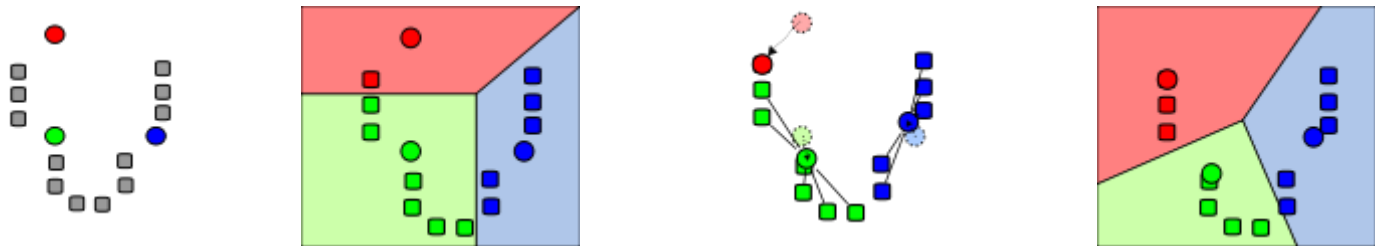

Überblick: Clustering

- Hierarchisches Clustern, spectral Clustering.
- Christoph Sawade.

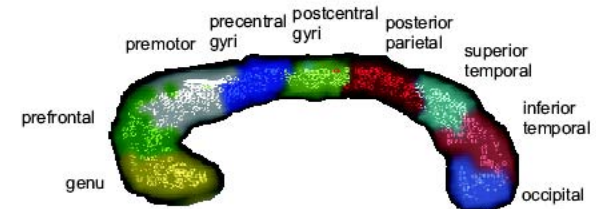
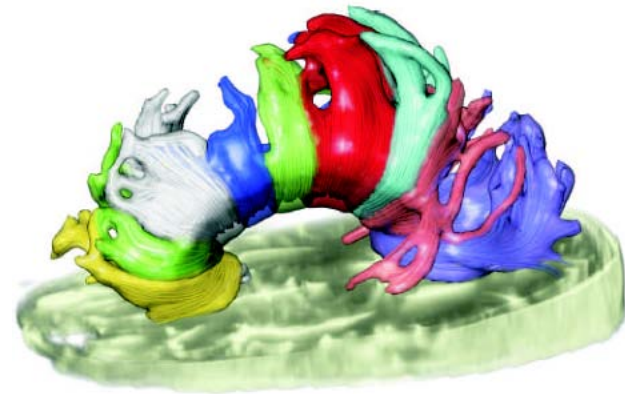

Überblick: Bayes Point Machine

- Bayes-optimale SVM-Lösung.
- Christoph Sawade.

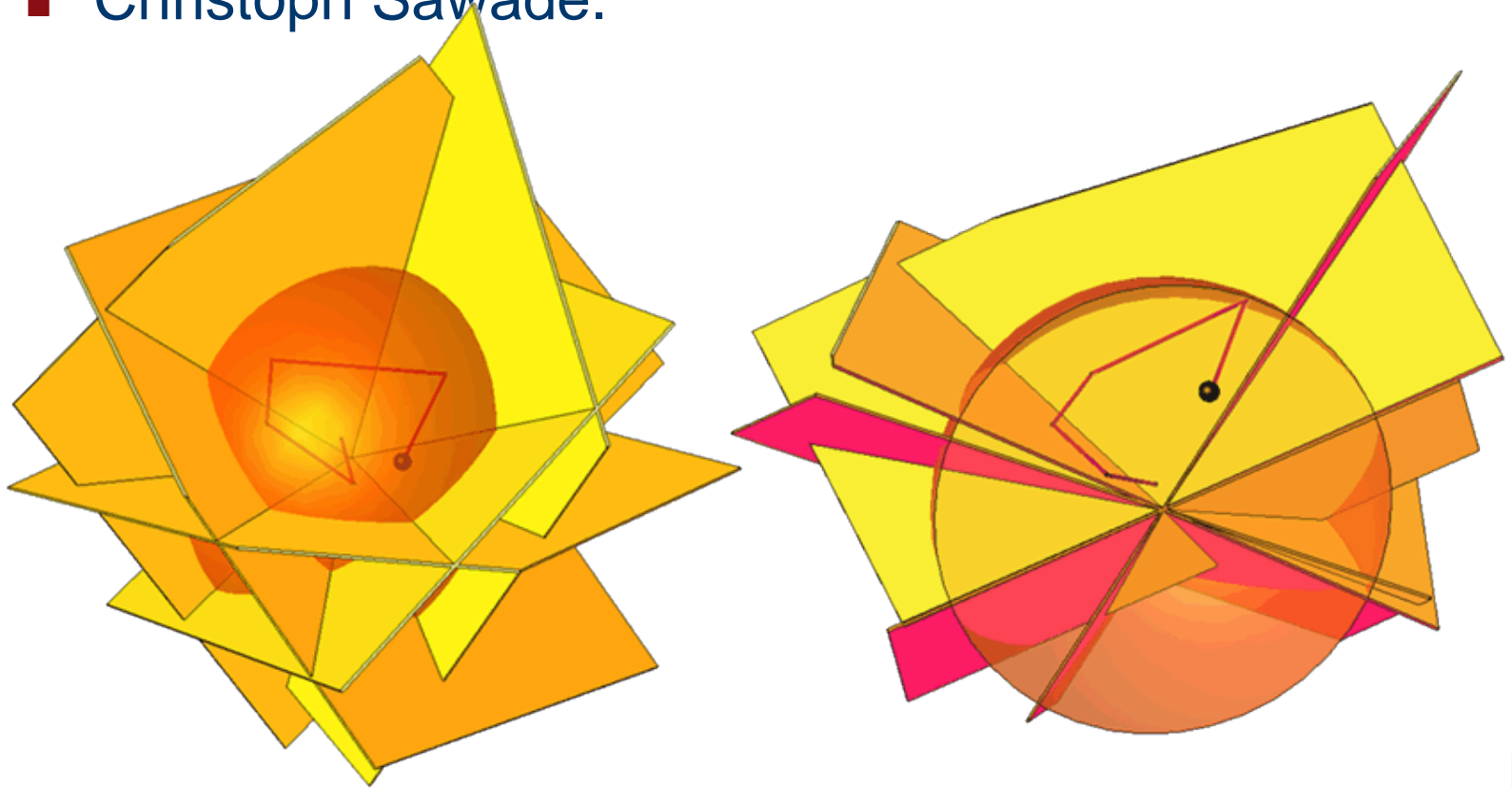

Überblick: Covariate Shift, Multi-Task

- Trainingsverteilung ungleich Testverteilung.
- Tobias Scheffer.

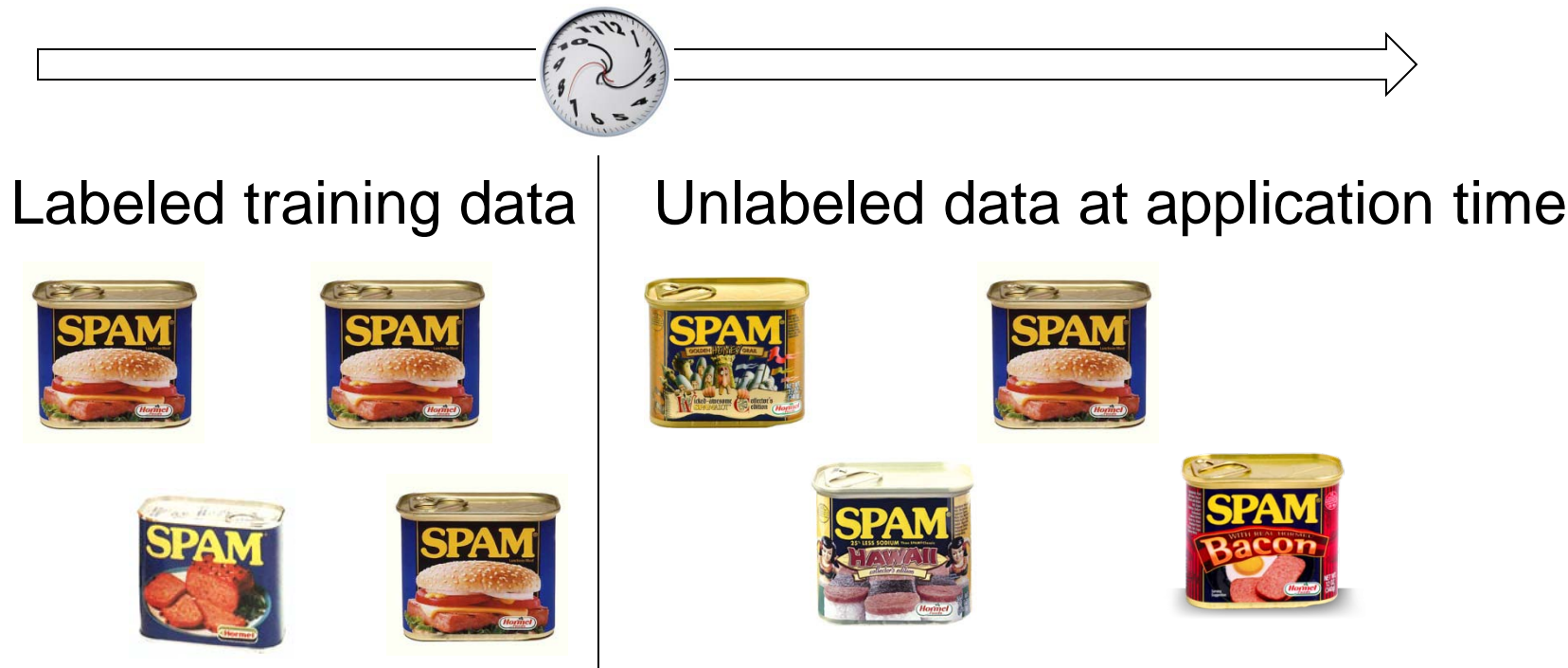

Überblick: Aktives Lernen

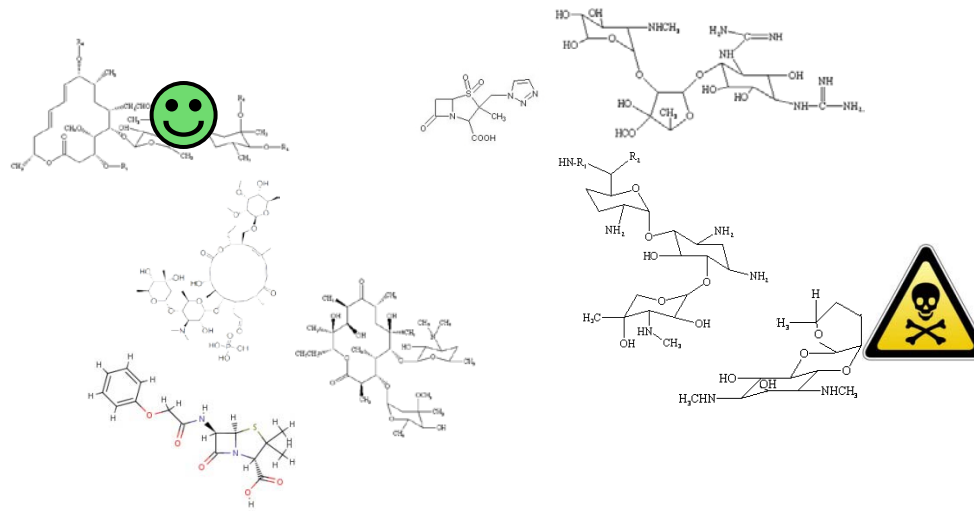

Überblick: Aktives Lernen

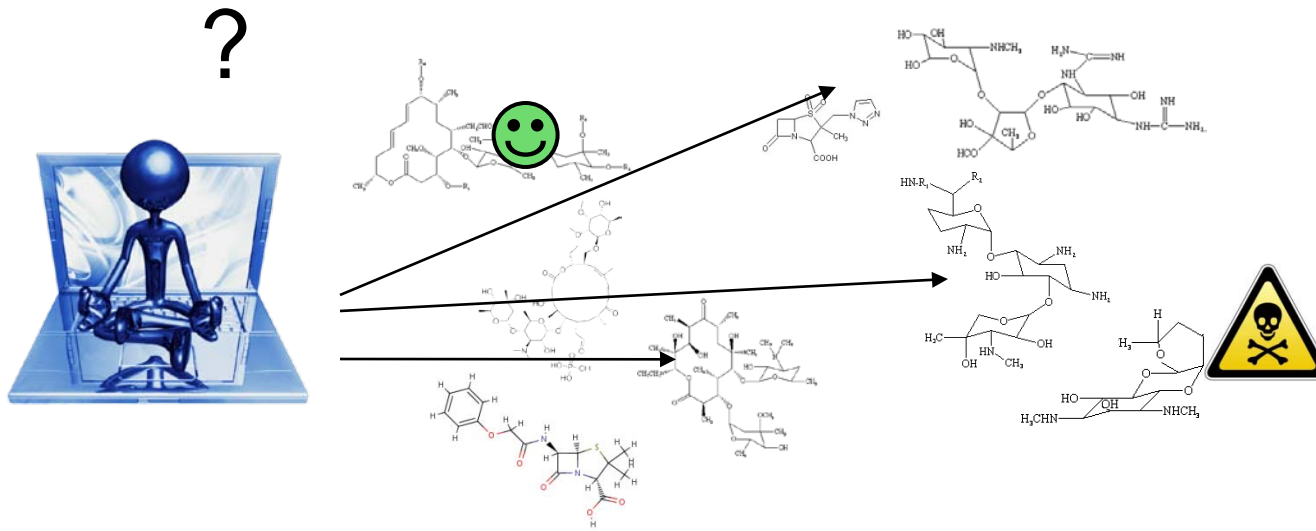

Überblick: Aktives Lernen

- Nur informative Beispiele labeln.
- Christoph Sawade.

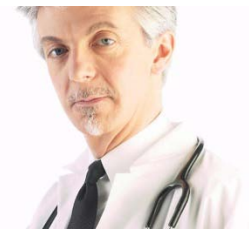
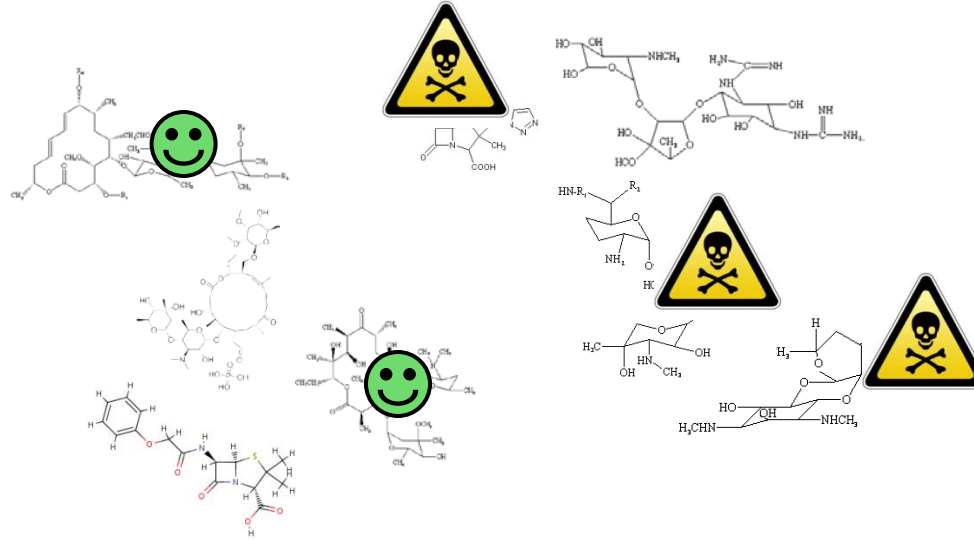

Überblick: Reinforcement-Lernen

- Uwe Dick.

Überblick: Recommender-Systeme

The screenshot shows the Netflix website interface. At the top, the Netflix logo is displayed in white on a red background. Below the logo, there are navigation tabs: "Welcome", "How It Works", "Browse Selection", "Start Your FREE Trial", and "Free Trial Info". The main heading is "Browse Selection". Below this, there is a section titled "Action & Adventure" with the text "Netflix carries over 2,700 Action & Adventure DVDs". Three movie covers are shown: "Ghost Rider", "Blood Diamond", and "Casino Royale". A tooltip is visible over the "Casino Royale" cover, providing details about the movie. The tooltip text includes: "Casino Royale (2006)", "Martin Campbell (GoldenEye) directs this film adaptation (the 21st of the Bond franchise) of Ian Fleming's first novel. Daniel Craig debuts as the new Bond who takes on a corrupt financier (Mads Mikkelsen) in a showdown of Texas Hold 'Em. You'll learn Bond's back story as the action-packed film takes you to the Bahamas, Madagascar and other exotic locales. Eva Green stars as Vesper Lynd, and the sublime Judi Dench reprises her role as M.", "Starring: Daniel Craig, Judi Dench", "Director: Martin Campbell", "Genre: Action & Adventure", "MPAA: PG-13", and "3.9 Customer Average". The browser's address bar shows the URL "http://www.netflix.com/Movie/Casino_Royale/70044604".

NETFLIX Buy / Redeem Gift | Memb

Welcome How It Works **Browse Selection** Start Your FREE Trial Free Trial Info

Browse Selection

You'll be able to choose from over 90,000 DVD titles - from classic to new releases. You can also watch a variety of familiar movies, TV episodes, and TV shows. Some titles may require an additional charge.

Action & Adventure

Netflix carries over 2,700 Action & Adventure DVDs

[Ghost Rider](#) [Blood Diamond](#) [Casino Royale](#)

[Mission: Impossible](#)

Casino Royale (2006)

Martin Campbell (GoldenEye) directs this film adaptation (the 21st of the Bond franchise) of Ian Fleming's first novel. Daniel Craig debuts as the new Bond who takes on a corrupt financier (Mads Mikkelsen) in a showdown of Texas Hold 'Em. You'll learn Bond's back story as the action-packed film takes you to the Bahamas, Madagascar and other exotic locales. Eva Green stars as Vesper Lynd, and the sublime Judi Dench reprises her role as M.

Starring: Daniel Craig, Judi Dench
Director: Martin Campbell
Genre: Action & Adventure
MPAA: PG-13

★★★★ 3.9 Customer Average

http://www.netflix.com/Movie/Casino_Royale/70044604

Überblick: Evaluierung, Tests

- Ist Verfahren A wirklich besser als B?
- Christoph Sawade, Niels Landwehr.

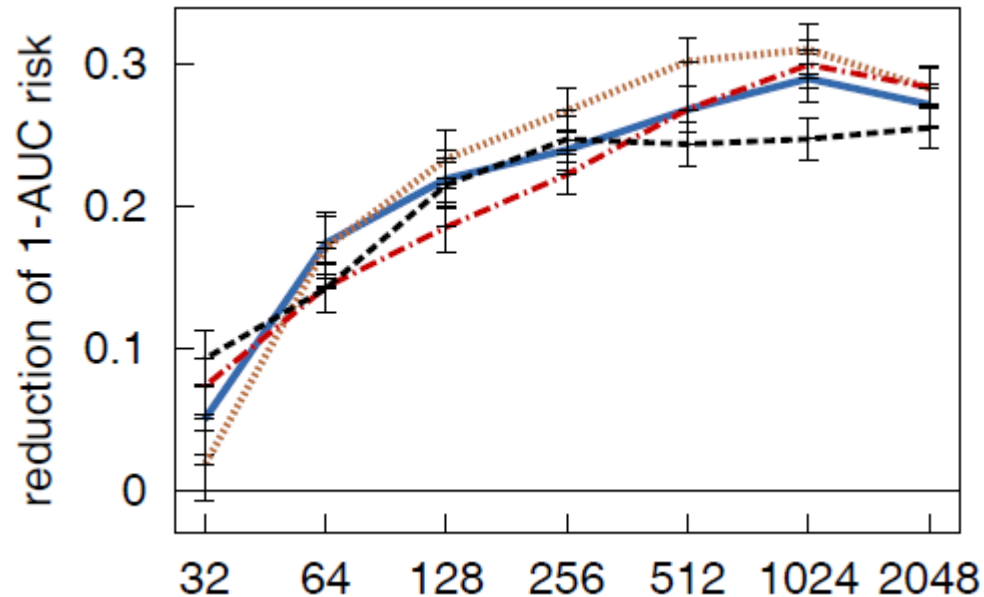

Fragen?